

KNX Manual

DALI Broadcast Controller

DM 4 DALI KNX



4940300

Contents

1	Functional characteristics	3
2	Operation and LED display	4
3	Technical data	5
3.1	Important information	6
4	General information about KNX Secure	7
4.1	Start-up with "KNX Data Secure"	7
4.2	Start-up without "KNX Data Secure"	8
5	General information about DALI	9
5.1	DALI system description	9
5.2	Schematic diagram	10
5.3	Response of DALI participants to EB operating voltage failure	10
5.4	Response of DALI participants at restoration of operating voltage	10
6	The DM 4 DALI KNX application programme	11
6.1	Selection in the product database	11
6.2	Overview of communication objects	12
6.3	Description of communication objects	16
6.4	Parameter pages overview	22
6.5	General parameters	23
6.6	Parameters for the DALI actuator	24
7	Application example	39
7.1	Bedroom lighting	39
8	Appendix	42
8.1	Priority order	42
8.2	Use of the soft switch function	42
8.3	Use of the force function	49
8.4	DALI EB	50
8.5	4-bit telegrams (brighter/darker)	50
8.6	The scenes	52
8.7	Conversion of percentages to hexadecimal and decimal values	56

1 Functional characteristics

- DALI actuator 4x DALI outputs + KNX bus terminal
- Parallel connection of DALI operating devices to one output
- Channel-dependent communication via broadcast commands.
- No individual or group control of DALI operating devices
- Provides DALI voltage for outputs
- Switching
- Soft switching
- Dimming (relative, absolute, dimming curve, dimming time, ...)
- Colour control (RGB, RGBW, colour temperature)
- Participation in central objects
- Scenes (8 scene memories per channel)
- Block function
- Force function
- Hour counter and service
- Diagnostic messages
- Channel buttons for Manual operation of the individual DALI outputs
- Button for changing over the Manual mode
- Configuration and start-up via ETS
- Support of KNX Data Secure
- Power supply via mains connection

2 Operation and LED display

Channel buttons

Each channel has the two keys "+" and "-". The outputs can be operated manually with these buttons.

When pressing repeatedly, the increments of 0% – 25% – 50% – 75% – 100% are selectable. The set minimum dimming value is observed with the increments.

Manual operation of the channels via the channel buttons can be blocked or enabled via a general parameter. The enable applies to the entire device. Individual channels cannot be set.

Manual button

The device can be set to Manual mode via button or object. Bus telegrams are not processed in Manual mode. The objects received during Manual mode will not be caught up.

The function of the Manual button can be blocked or enabled via a general parameter. An activated Manual applies to the duration of the time, which can be set via the parameter. After that, Manual will be automatically deactivated.

After a bus failure, Manual mode will be reset.

LED display

Manual mode

Manual mode is displayed via an LED.

When active, the LED lights up.

If Manual mode is blocked by parameters, the LED flashes when the button is pressed.

Channel

Each channel has two LEDs. The upper one shows the current state of the channel. The LED is on when the dimming value is > 0%.

If the operation of the buttons is blocked by parameters, the LED associated with the button flashes while the button is pressed.

Event of malfunction

The lower LED of a channel indicates an error due to overload, short circuit, or mains failure. The lower LED flashes in the event of malfunction.

In the event of a short circuit, the upper LED of the affected channel flashes in addition to the lower LED.

3 Technical data

Operating voltage	110 – 240 V AC, +10% / -15%
Frequency	50 – 60 Hz
Power consumption KNX	< 10 mA
KNX operating voltage	21 – 31 V
permissible ambient temperature	-5 °C ... +45 °C
Protection rating	IP 20
Protection class	II subject to designated installation
Width	4 TE
Type of installation	Series mounting, DIN-rail
Connection type	DM 4: Screw terminals bus connection: KNX bus terminal
Max. terminal cross section	1x 4 mm ² flexible with crimp terminal, or 1x 6 mm ² rigid
Number of channels	4 channels
Max. current (per channel)	60 mA
Status display	Yes
Manual operation	Yes (Off, 25%, 50%, 75%, 100%)

3.1 Important information

-
- ① The DALI actuator controls devices with DALI interface (e.g. EBs, LED converters, transformers, etc.).
 - ① The device is a **Single Master Application Controller** (according to EN 62386-103), i.e. it is only allowed to be operated in DALI segments with connected EBs, and **not** with other DALI control devices within the segment (no multi master operation).
 - ① Up to 30 DALI participants can be connected to one DALI output. The DALI participants are addressed per channel via broadcast commands. Addressing or grouping of the DALI devices is not necessary.
 - ① The DALI actuator acts as an interface between the DALI system and the KNX bus. For switching and dimming the connected DALI devices.
 - ① Ensure double basic insulation between KNX installation and mains voltage, i.e. the wires of the KNX line have to be insulated up to the bus connection terminal using the supplied shrink tubing.
 - ① For the entire DALI installation of a segment, a maximum cable length of 300 m must not be exceeded (\varnothing 1.5 mm²).
 - ① The mains voltage is connected according to the printing on the housing (L and N). The connection to the KNX bus is established with the KNX plug-in terminal. The lines of the DALI segments are connected to the corresponding terminals DA C1, DA C2, DA C3, or DA C4.
-

4 General information about KNX Secure

ETS5 Version 5.5 and higher support secure communication in KNX systems. A distinction is made between secure communication via the IP medium using KNX IP Secure and secure communication via the TP and RF media using KNX Data Secure. The following information refers to KNX Data Secure.

In the ETS catalogue, KNX products supporting "KNX-Secure" are clearly identified. 

As soon as a "KNX-Secure" device is included in the project, the ETS requests a project password. If no password is entered, the device is included with Secure Mode deactivated. However, the password can also be entered or changed later in the project overview.

4.1 Start-up with "KNX Data Secure"

For secure communication, the FDSK (Factory Device Setup Key) is required. If a KNX product supporting "KNX Data Secure" is included in a line, the ETS requires the input of the FDSK. This device-specific key is printed on the device label and can either be entered by keyboard or read by using a code scanner or notebook camera.

Example of FDSK on device label:



After entering the FDSK, the ETS generates a device-specific tool key. The ETS sends the tool key to the device to be configured via the bus. The transmission is encrypted and authenticated with the original and previously entered FDSK key. Neither the tool key nor the FDSK key are sent in plain text via the bus.

After the previous action, the device only accepts the tool key for further communication with the ETS.

The FDSK key is no longer used for further communication, unless the device is reset to the factory setting: In this case, all set safety-related data will be deleted.

The ETS generates as many runtime keys as needed for the group communication you want to protect. The ETS sends the runtime keys to the device to be configured via the bus.

Transmission takes place by encrypting and authenticating them via the tool key. The runtime keys are never sent in plain text via the bus.

The FDSK is saved in the project and can be viewed in the project overview.

All keys for this project can also be exported (backup).

During project planning, it can be defined subsequently which functions / objects are to communicate securely. All objects with encrypted communication are identified by the "Secure" icon in the ETS.



4.2 Start-up without "KNX Data Secure"

Alternatively, the device can also be put into operation without KNX Data Secure. In this case, the device is unsecured and behaves like any other KNX device without KNX Data Secure function.

To start up the device without KNX Data Secure, select the device in the 'Topology' or 'Devices' section and set the 'Secure start up' option in the 'Properties' area of the 'Settings' tab to 'Disabled'.

5 General information about DALI



The demands on modern lighting technology are very diverse. While in the past it was only a matter of providing light for visual tasks, today the focus is on features as comfort, ambience, functionality and energy saving. Furthermore, a modern lighting system is increasingly included in the facility management of the building installation, in order to monitor the status of the entire lighting system. Complex lighting management is often required to suit the premises and their use. All these requirements can only be met insufficiently or at a great expense by traditional 1-10 V technology. In view of this, the DALI standard (DIN EN 62386 formerly DIN EN 60929) was developed in cooperation with leading EB manufacturers. It describes and defines the DALI digital interface (Digital Addressable Lighting Interface) for operating devices in lighting technology.

DALI has established itself as a company-neutral standard in lighting engineering. The range of ballasts, transformers, dimmers and relays with DALI interface shapes modern lighting technology.

5.1 DALI system description

The DALI power supply is integrated in the DALI actuator, so no other power supply, e.g. DALI-PS, may be connected to the gateway.

As a DALI master, the DALI actuator sends broadcast telegrams. Broadcast telegrams are telegrams to which all DALI participants listen together, so the participants are all controlled simultaneously.

In contrast to 1-10 V technology, the DALI ballast (EB) contains an electronic switching element. Therefore, no separate relay is required for switching the EBs, and there is no need for a switching capacity calculation. The electronic switching element allows for silent switching.

5.2 Schematic diagram

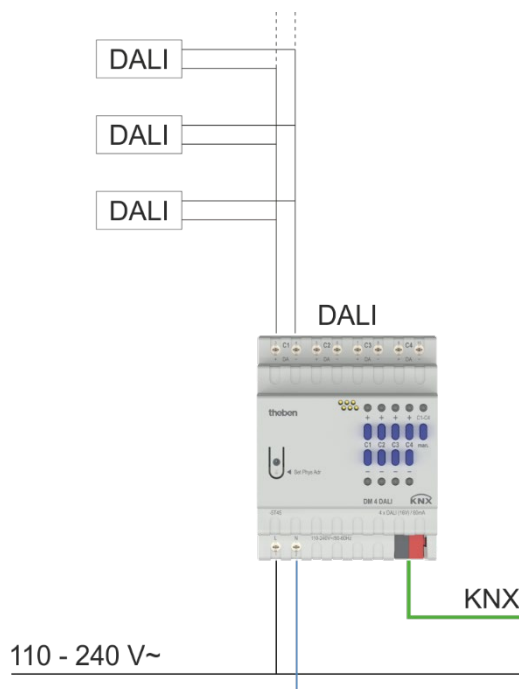

5.3 Response of DALI participants to EB operating voltage failure

The EB operating voltage failure, usually 230 V, at the DALI operating device, e.g. EB, causes the lamp to go out, and the ballast is no longer functioning.



Note: The DM 4 DALI recognises this condition as a mains error.

5.4 Response of DALI participants at restoration of operating voltage

In the delivery state, the operating devices with DALI interface usually behave in such a way that the lamps go to maximum brightness when the EB operating voltage is applied for the first time, or when the EB operating voltage is restored. This brightness value (power-on level) is specified by the EB manufacturer and represents a kind of safety function. During the start-up process, even without a programmed DALI master, the electrician can switch the DALI lighting on and off with a normal automatic circuit breaker by connecting and disconnecting the 230 V operating voltage.

6 The DM 4 DALI KNX application programme

6.1 Selection in the product database

Manufacturer	Theben AG
Product family	DALI
Product type	Dimmers
Programme name	DM 4 DALI KNX

Number of communication objects	135
Number of group addresses	254
Number of associations	255



The ETS database can be found on our website: www.theben.de/downloads

6.2 Overview of communication objects

6.2.1 Dimmer, channel C1

No.	Object name	Function	Length	R	W	C	T	DPT
1	Channel C1	Switching ON/OFF	1 bit	-	W	C	-	1.001
2	Channel C1	Brighter/darker	4 bit	-	W	C	-	3.007
3	Channel C1	Dimming value	1 byte	-	W	C	-	5.001
4	Channel C1	Soft switching	1 bit	-	W	C	-	1.001
5	Channel C1	Block	1 bit	-	W	C	-	1.001
6	Channel C1	Call up/save scenes	1 byte	-	W	C	-	18.001
7	Channel C1	Enable scenes = 1	1 bit	-	W	C	-	1.001
		Block scenes = 1	1 bit	-	W	C	-	1.001
8	Channel C1	Force	2 bit	-	W	C	-	2.001
		Dimming value with force	1 byte	-	W	C	-	5.001
		Force = 1	1 bit	-	W	C	-	1.001
		Force = 0	1 bit	-	W	C	-	1.001
9	Channel C1	Dimming value limit	1 byte	-	W	C	-	5.001
10	Channel C1	Feedback On/Off	1 bit	R	-	C	T	1.001
11	Channel C1	Feedback in %	1 byte	R	-	C	T	5.001
12	Channel C1	Operating hours feedback	4 bytes	R	-	C	T	13.100
		Time to next service	4 bytes	R	-	C	T	13.100
13	Channel C1	Service required	1 bit	R	-	C	T	1.001
14	Channel C1	Reset service	1 bit	-	W	C	-	1.001
		Reset operating hours	1 bit	-	W	C	-	1.001
15	Channel C1	General error message	1 bit	R	-	C	T	1.001
16	Channel C1	Fault DALI bus	1 bit	R	-	C	T	1.001
17	Channel C1	Lamp failure	1 bit	R	-	C	T	1.001
18	Channel C1	Mains power failure	1 bit	R	-	C	T	1.001
19	Channel C1	Colour control RGB	3 bytes	-	W	C	-	232.600
		Colour temperature	2 bytes	-	W	C	-	7.600
		Colour control RGBW	6 bytes	-	W	C	-	251.600
20	Channel C1	Colour control RGB (red)	1 byte	-	W	C	-	5.001
		Colour control (colour hue)	1 byte	-	W	C	-	5.003
		Relative colour temperature	1 byte	-	W	C	-	5.001
21	Channel C1	Colour control RGB (green)	1 byte	-	W	C	-	5.001
		Colour control (saturation)	1 byte	-	W	C	-	5.001
22	Channel C1	Colour control RGB (blue)	1 byte	-	W	C	-	5.001
23	Channel C1	Colour control white	1 byte	-	W	C	-	5.001
24	Channel C1	Colour change RGB (red)	4 bit	-	W	C	-	3.007
		Colour change (colour hue)	4 bit	-	W	C	-	3.007
		Colour temperature change	4 bit	-	W	C	-	3.007
25	Channel C1	Colour change RGB (green)	4 bit	-	W	C	-	3.007
		Colour change (saturation)	4 bit	-	W	C	-	3.007
26	Channel C1	Colour change RGB (blue)	4 bit	-	W	C	-	3.007
27	Channel C1	Colour change white	4 bit	-	W	C	-	3.007
28	Channel C1	Colour status RGB	3 bytes	R	-	C	T	232.600
		Colour status RGBW	6 bytes	R	-	C	T	251.600
		Colour temperature status	2 bytes	R	-	C	T	7.600
29	Channel C1	Colour status (RGB red)	1 byte	R	-	C	T	5.001

No.	Object name	Function	Length	R	W	C	T	DPT
		<i>Colour status (colour hue)</i>	<i>1 byte</i>	<i>R</i>	<i>-</i>	<i>C</i>	<i>T</i>	<i>5.003</i>
<i>30</i>	<i>Channel C1</i>	<i>Colour status (RGB green)</i>	<i>1 byte</i>	<i>R</i>	<i>-</i>	<i>C</i>	<i>T</i>	<i>5.001</i>
		<i>Colour status (saturation)</i>	<i>1 byte</i>	<i>R</i>	<i>-</i>	<i>C</i>	<i>T</i>	<i>5.001</i>
<i>31</i>	<i>Channel C1</i>	<i>Colour status (RGB blue)</i>	<i>1 byte</i>	<i>R</i>	<i>-</i>	<i>C</i>	<i>T</i>	<i>5.001</i>
<i>32</i>	<i>Channel C1</i>	<i>Colour status white</i>	<i>1 byte</i>	<i>R</i>	<i>-</i>	<i>C</i>	<i>T</i>	<i>5.001</i>

Objects 41-160 for C2-C4: Same function as C1.

6.2.2 Object numbers, channel-related objects

C1	C2	C3	C4
1	41	81	121
2	42	82	122
3	43	83	123
4	44	84	124
5	45	85	125
6	46	86	126
7	47	87	127
8	48	88	128
9	49	89	129
10	50	90	130
11	51	91	131
12	52	92	132
13	53	93	133
14	54	94	134
15	55	95	135
16	56	96	136
17	57	97	137
18	58	98	138
19	59	99	139
20	60	100	140
21	61	101	141
22	62	102	142
23	63	103	143
24	64	104	144
25	65	105	145
26	66	106	146
27	67	107	147
28	68	108	148
29	69	109	149
30	70	110	150
31	71	111	151
32	72	112	152
33	73	113	153
34	74	114	154
35	75	115	155
36	76	116	156
37	77	117	157
38	78	118	158
39	79	119	159
40	80	120	160

6.2.3 Common objects

No.	Object name	Function	Length	R	W	C	T	DPT
161	Central	Set/reset Manual button	1 bit	-	W	C	-	1.001
162	Central	Report Manual button	1 bit	R	-	C	T	1.001
163	Central	Central permanent ON	1 bit	-	W	C	-	1.001
164	Central	Central permanent OFF	1 bit	-	W	C	-	1.001
165	Central	Central switching	1 bit	-	W	C	-	1.001
166	Central	Call up/save central scenes	1 byte	-	W	C	-	18.001
167	Firmware version	Sending	2 byte	R	-	C	T	217.001

6.3 Description of communication objects

6.3.1 Objects for DALI actuator

Object 1: Switching ON/OFF

1 = switch on load.

0 = switch off load.

See also: Parameter Switch-on value.

Object 2: Brighter/darker

This object is actuated with 4-bit telegrams (DPT 3,007 Control Dimming).

This function can be used to incrementally dim the light up or down.

In the standard application, telegrams are sent with 64 increments.

IMPORTANT: The response to 4-bit telegrams depends on the parameter

Switching On and Off with a 4-bit telegram.

See appendix: [*4-bit telegrams \(brighter/darker\)*](#)

Object 3: Dimming value

This object can be used to select the desired dimming value directly.

Format: 1 byte percentage value.

0 = 0%

255 = 100%

Object 4: Soft switching

A 1 on this object starts a soft switching cycle, i.e.:

The brightness is gradually increased, starting from the minimum brightness.

Afterwards, the dimming value remains constant for the configured time. After this time has elapsed, the light is gradually dimmed down to the configured value after Soft OFF.

The configured minimum and maximum dimming value is taken into account.

The cycle can be extended or prematurely terminated via telegrams.

This sequence can also be controlled using a time switch if the Time between soft ON and soft OFF parameter is set to Until soft OFF telegram.

The dimming cycle is then started with a 1 and finished with a 0.

See appendix: [*Use of the soft switch function*](#)

Object 5: Block

Responses to the block being set and cancelled can be configured if the block function has been activated (**Configuration options** parameter page).

The block only applies when the object is received, i.e. with 0 the channel is not blocked after restoration of the bus supply.

If the parameter Behaviour when setting the block = no reaction, a running soft-switch process will not be interrupted.

Object 6: Call up/save scenes

Only available if the scene function has been activated (**Configuration options** parameter page).

This object can be used to save and subsequently call up scenes.

Saving stores the dimming value and, if selected, also the colour value of the channel.

It does not matter how this dimming value is produced (whether via switch commands, central objects or the buttons on the device).

When calling up, the stored dimming and colour value will be restored.

All scene numbers from 1 to 63 are supported.

The channel can participate in up to 8 scenes.

See appendix: [Scenes](#)

Object 7: Enable scenes = 1, block scenes = 1

Blocks the scene function with a 1 or a 0 depending on the configuration.

As long as it is blocked, scenes cannot be saved or called up.

Object 8: Force, dimming value during force, force = 1, force = 0

The function of the force object can be configured as a 1-bit, 2-bit or 1-byte object.

Format of force object	Force		Response with force	
	trigger with	end with	Begin	End
1 bit	1 or 0 (configurable)	0 or 1 (configurable)	configurable in the application program	
2 bit	Force On = 3 Force Off = 2	Deactivate force = 0 or 1	configurable in the application program.	Configurable
1 byte	1-100%	0	The triggering telegram acts simultaneously as a force dimming value	Configurable

A colour value is also sent, see parameter *Colour value or: Colour temperature at permanent RGB* on the parameter page **Colour value**.

Object 9: Dimming value limit

The dimming value can be temporarily restricted via object Dimming value limit. This is used, for example, to ensure that basic lighting is not exceeded at night, while during the evening the full range of lighting can be used.

If the object value = 0, the dimming value is not restricted.

If the object value is greater than 0, then this value indicates the limit for the dimming value.

If the object value is smaller than the configured minimum dimming value, then the brightness is restricted to this minimum dimming value.

If the restriction is removed, the dimming value continues to remain restricted until a new dimming command is received.

During the restriction, the Soft ON and Soft OFF times are adjusted in such a way that the speed of the brightness change remains the same as when there are no restrictions.

Object 10: Feedback On/Off

Sends the current dimming status:

1 = current dimming value is between 1% and 100%

0 = current dimming value is 0%

Object 11: Feedback in %

Sends the new dimming value after a change as soon as a dimming process is completed, i.e. once the new set point value has been reached.

Format: 1 byte, 0 ... 255 i.e. 0 ... 100%

Object 12: Operating hours feedback, time to next service

Only available if the operating hours counter function has been activated (**Configuration options** parameter page).

Reports, depending on selected type of hour counter (**Hour counter and service** parameter page), either the remaining period to the next set service or the current status of the hour counter.

Object 13: Service required

Only available if the hour counter function has been activated (**Configuration options** parameter page) and Type of hour counter = Counter for time to next service.

Reports if the next service is due.

0 = not due

1 = service is due

Object 14: Reset service, reset operating hours

Only available if the hour counter function is activated. (**Configuration options** parameter page).

Object 15: General error message

Used as a malfunction signal:

0 = no error

1 = an error has been detected

A general error occurs when one of the other errors has been detected. This message can, for example, be shown on a display.

Object 16: Fault DALI bus

Fault DALI bus has been detected.

(overload or short circuit)

In case of overload, the measured current on the DALI bus is too high.

In case of a short circuit, the measured voltage on the DALI bus is too low.

Object 17: Lamp failure

Reports a lamp malfunction.

Object 18: Mains power failure

0 = OK

1 = no mains voltage present at DM 4 DALI KNX:
mains failure or defective hardware.

Colour temperature function

Object 19: Absolute colour temperature (2 byte)

DPT 7.600. Receives colour temperature telegrams from 1000 to 10000 K.

Object 20: Relative colour temperature (1 byte)

DPT 5.001. The colour temperature can be set via this object. The object is a % value and sets the colour temperature as a percentage between minimum and maximum colour temperature.

Object 24: Colour change

DPT 3.007. The colour temperature can be changed via this object. Independent of the bits 0..2 in the 4-bit dimming telegram, the complete range of 0..100% is always run through.

Object 28: Colour temperature status

DPT 7.600. The colour temperature is reported via this object.

RGB / RGBW function

- i** With these colour values, the colour components can either be sent together in one object or separately to several objects.
In HSV or HSVW format, the output is exclusively via separate objects.

Objects 19-32: Colour control

Function	Type	No.	Object function	
<i>RGB colour control</i> (approaching a fixed value)	<i>RGB 3 bytes</i>	19	<i>Colour control RGB</i>	
		<i>RGB separate objects</i>	20	<i>RGB red</i>
			21	<i>RGB green</i>
	<i>HSV separate objects</i>	22	<i>RGB blue</i>	
		20	<i>HSV colour hue</i>	
		21	<i>HSV saturation</i>	
<i>RGB colour change</i> (moving by a certain value)	<i>RGB separate objects</i>	24	<i>RGB red</i>	
		25	<i>RGB green</i>	
		26	<i>RGB blue</i>	
	<i>HSV separate objects</i>	24	<i>HSV colour hue</i>	
		25	<i>HSV saturation</i>	
<i>RGB colour status</i> (send value on bus)	<i>RGB 3 bytes</i>	28	<i>Colour status RGB</i>	
		<i>RGB separate objects</i>	29	<i>RGB red</i>
	30		<i>RGB green</i>	
	31		<i>RGB blue</i>	
	<i>HSV separate objects</i>	29	<i>HSV colour hue</i>	
		30	<i>HSV saturation</i>	
<i>RGBW colour control</i> (approaching a fixed value)	<i>RGBW 6 bytes</i>	19	<i>Colour control RGBW</i>	
		<i>RGBW separate objects</i>	20	<i>RGB(W) red</i>
	21		<i>RGB(W) green</i>	
	22		<i>RGB(W) blue</i>	
	23		<i>White level</i>	
	<i>HSVW separate objects</i>	20	<i>HSV(W) colour hue</i>	
		21	<i>HSV(W) saturation</i>	
		23	<i>White level</i>	
	<i>RGBW colour change</i> (moving by a certain value)	<i>RGBW separate objects</i>	24	<i>RGB(W) red</i>
25			<i>RGB(W) green</i>	
26			<i>RGB(W) blue</i>	
27			<i>White level</i>	
<i>HSVW separate objects</i>		24	<i>HSV(W) colour hue</i>	
		25	<i>HSV(W) saturation</i>	
		27	<i>White level</i>	
<i>RGBW colour status</i> (send value on bus)	<i>RGBW 3 bytes</i>	28	<i>Colour status RGBW</i>	
		<i>RGB separate objects</i>	29	<i>RGB(W) red</i>
	30		<i>RGB(W) green</i>	
	31		<i>RGB(W) blue</i>	
	32		<i>White level</i>	
	<i>HSV separate objects</i>	29	<i>HSV(W) colour hue</i>	
		30	<i>HSV(W) saturation</i>	
		32	<i>White level</i>	

6.3.2 Common objects

Object 161: Set/reset Manual button

Manual mode can be set/reset via an object. The object value 0 also resets a temporary key lock, if configured.

Object 162: Report Manual button

The status of the Manual mode can be read via a DPT 1.001 object.

Object 163: Central permanent ON

Central switch-on function.

0 = no function

1 = permanent ON

Participation in this object can be set (**Configuration options** parameter page).



This object has the second highest priority after the buttons on the device. As long as it is set, other switch commands will not work on the participating channel.

Object 164: Central permanent OFF

Central switch-off function.

0 = no function

1 = permanent OFF

Participation in this object can be set (**Configuration options** parameter page).



This object has the third highest priority after Central permanent ON and the device buttons. As long as it is set, other switch commands will not work on the participating channel.

Object 165: Central switching

Central switch function.

0 = OFF

1 = ON

Participation in this object can be set (**Configuration options** parameter page). With this object, the participating channel responds exactly as if its input object were receiving a switch command.

Object 166: Call up/save central scenes

Central object for using scenes.

This object can be used to save and subsequently call up scenes.

See appendix: [Scenes](#)

Object 167: Send firmware version

The version of the firmware can be queried via the DPT 217.001 object.

6.4 Parameter pages overview

6.4.1 General

Parameter page	Description
General	Activating channel buttons and Manual button.

6.4.2 DALI actuator

Parameter page	Description
Channel	
Configuration options	Characteristics of channel and activation of additional functions (colour control, soft switching, force, etc.).
Colour control	Kind and object type of colour control, as well as other functions (colour value at permanent, response when switching on, etc.).
Dimming response	Dimming times, dimming switch-on value, etc.
Dimming value limits	Scope of the limit.
Soft switching	Brightness/dimming value, colour values and time settings for soft switching.
Block function	Type of block telegram and response to blocking.
Feedback	Format of the feedback objects and cyclical transmission time.
Force	Response in forced operation.
Scenes	Selection of scene numbers relevant to the channel.
Hour counter and service	Type of hour counter and, if applicable, service interval, etc.
Diagnostic messages	Activate transmission of the diagnostic and error messages.
Power failure and restoration	Response in the event of download and bus failure, restoration of the mains and bus supply.

6.5 General parameters

6.5.1 General

Designation	Values	Description
<i>Channel buttons</i>	<p><i>blocked</i></p> <p><i>Enabled</i></p>	<p>Manual operation of the channels via the channel buttons will be blocked.</p> <p>Manual operation of the channels via the channel buttons will be enabled. The enable applies to the entire device. Individual channels cannot be set.</p>
<i>Manual button</i>	<p><i>blocked</i></p> <p><i>applies until reset via object</i></p> <p><i>applies for 30 minutes or until reset via obj.</i></p> <p><i>applies for 1 h or until reset via obj.</i></p> <p><i>applies for 2 h or until reset via obj.</i></p> <p><i>applies for 4 h or until reset via obj.</i></p> <p><i>applies for 8 h or until reset via obj.</i></p> <p><i>applies for 12 h or until reset via obj.</i></p> <p><i>applies for 24 h or until reset via obj.</i></p>	<p>The function of the Manual button can be blocked or enabled via the parameter.</p> <p>An activated Manual applies to the duration of the time. After that, Manual will be automatically deactivated.</p> <p>Bus telegrams are not processed in Manual mode. The objects received during Manual mode will also not be caught up.</p> <p>After a bus failure, Manual mode will be reset.</p>

6.6 Parameters for the DALI actuator

6.6.1 Channel: Configuration options

Designation	Values	Description
Activating colour control	<i>no</i> <i>yes</i>	<i>No colour control.</i> The page Colour control will be shown.
Adjust dimming value limits	<i>no</i>	The standard values apply: <i>Implement limit when executing the object</i> = <i>no</i> <i>Limit applies for:</i> - <i>Soft switching,</i> - <i>absolute dimming,</i> - <i>relative dimming,</i> - <i>switch command</i> = <i>no</i>
	<i>yes</i>	The page Dimming value limits will be shown and all parameters can be adjusted individually.
Adjust soft switching	<i>no</i>	The standard values apply: - <i>time for Soft ON = 1 min</i> - <i>Dimming value after Soft ON = 100%</i> - <i>Time between Soft ON and Soft OFF = 5 min</i> - <i>Dimming value after Soft OFF = 0%</i> - <i>Time for Soft OFF = 1 min</i>
	<i>yes</i>	The page Soft switching will be shown and all parameters can be adjusted individually.
Adjust block function	<i>no</i>	The standard values apply: - <i>Block with 1 (standard)</i> - <i>Response when setting the block = 10%</i> - <i>Behaviour when cancelling the block = update</i>
	<i>yes</i>	The page Block function will be shown and all parameters can be adjusted individually.
Participation in central objects	<i>no</i>	Central objects are not taken into account.

6.6.2 Colour control

This parameter can be used to set which colour control is to be used on the respective channel.

Note: Make sure that the EBs connected to this channel support this type of control.

Designation	Values	Description
<i>Type of colour control</i>	<i>Colour temperature</i> 1000 – 10000 K	Colour temperature
	RGB colour	The colour can be selected directly via the Color Picker. The colour value is additionally displayed as a 3 byte hexadecimal value.
	<i>RGBW colour</i>	The colour can be selected directly via the Color Picker. The colour value is additionally displayed as a 3 byte hexadecimal value.
<i>Object type</i>	With RGB colour	
	RGB combined	1 RGB object 3 byte DPT232.600
	<i>RGB separate objects</i>	3 objects: red, green, blue.
	<i>HSV separate objects</i>	2 objects: Colour value (hue), colour saturation (saturation).
	With RGBW colour	
	RGBW combined	1 RGBW object 6 byte DPT251.600
	<i>RGBW separate objects</i>	4 objects: red, green, blue, white level (white).
<i>Colour at permanent</i>	With RGB(W) colour	
	<i>Colour value at Permanent RGB(W)</i> #000000 – #FFFFFF	During Permanent ON and Force, the configured colour is set when colour control is activated
	<i>Additional white level Permanent (RGBW) #00 ... #FF</i>	
	At colour temperature	
	<i>Colour temperature at Force/Permanent On</i> 1000 – 10000 K 3000 K	This parameter can be used to set which colour temperature is to be used for Force and Permanent On.
<i>Response when switching on</i>	Last object value	The last object value is used. Note: If the object value is invalid, the preset colour of the ETS is used.
	<i>ETS parameters</i>	Use ETS parameters as set below
<i>Colour when switching on</i>	At colour temperature	
	<i>Colour temperature</i> 1000 – 10000 K 3000 K	This parameter can be used to set which colour temperature is to be used when switching on.

Designation	Values	Description
	With RGB(W) <i>Colour value when switching on RGB(W)</i> #000000 – #FFFFFF <i>Additional white level when switching on (RGBW)</i> #00 ... #FF	This parameter can be used to set which colour is to be used when switching on.
<i>Minimum colour temperature</i>	1000 K..5000 K 2000 K	Parameter for setting the minimum valid value for the colour temperature. The minimum colour temperature is required for the calculation of the relative colour temperature.
<i>Maximum colour temperature</i>	5010 K..10000 K 6000 K	Parameter for setting the maximum valid value for the colour temperature. The maximum colour temperature is required for the calculation of the relative colour temperature. Both parameters are used for calculation and determine the settable values
<i>Time during colour change via dimming</i>	1 s, 2 s, 4 s 6 s, 8 s, 12 s, 15 s, 24 s, 30 s, 60 s, 90 s	This parameter is used to decide how quickly the colour value should be changed when dimming.
<i>Time during colour change</i>	immediately 1 s, 2 s, 4 s 6 s, 8 s, 12 s, 15 s, 24 s, 30 s, 60 s, 90 s	This parameter is used to decide how quickly the colour value should be changed.

Designation	Values	Description
	<i>soft on with dimming time 1</i> <i>soft on with dimming time 2</i> <i>soft on with dimming time 3</i>	The change to the new dimming value takes place within the preset dimming time, proportionately to the change in value. Example with dimming time 1 = 12 s: Change from: - 0 to 100% or 100 to 0% in 12 s (= 100% of 12 s) - 25 to 50% or 50 to 25% in 3 s (= 25% of 12 s) etc.
<i>Switch-on value</i>	<i>Value before previous switch-off</i> <i>minimum value</i> <i>10%, 20%, 30%</i> <i>40%, 50%, 60%</i> <i>70%, 80%, 90%, 100%</i>	The last dimming value before switching off is saved and restored. The configured minimum value is applied. The dimmer adopts the selected value after it is switched on. Here again the configured <i>minimum dimming value</i> will be taken into account.
<i>Switch-on with 4-bit dim teleg.</i>	 <i>no</i> <i>yes</i>	Defines the response if the channel is switched off and a 4-bit telegram (brighter) is received. See appendix: <u><i>4-bit telegrams</i></u> (brighter / darker). Channel status remains unchanged. Channel is switched on and dimmed.
<i>Switching off with a 4-bit dim teleg.</i>	 <i>no</i> <i>yes</i>	Defines the response if the channel is switched on and a 4-bit telegram (darker) is received. See appendix: <u><i>4-bit telegrams</i></u> (brighter / darker). Channel status remains unchanged. Channel is switched off.



6.6.4 Dimming value limits

i The dimming value can be temporarily restricted via object *Dimming value limit*. This is used, for example, to ensure that basic lighting is not exceeded at night, while during the evening the full range of lighting can be used.

Object description, see object 9: Dimming value limit.

Designation	Values	Description
<i>Perform limit in describing object</i>	no <i>yes</i>	Limit not applied until next dimming process. Limit the dimming value as soon as a value is received on the <i>dimming value limit</i> object.
<i>Limit applies to switch command (1-bit)</i>	no <i>yes</i>	No limit during switch commands. Limit is effective.
<i>Limit applies to relative dimming (4-bit)</i>	no <i>yes</i>	No limit during brighter/darker commands. Limit is effective.
<i>Limit applies to absolute dimming (8-bit)</i>	no <i>yes</i>	No limit for percentage value telegrams. Limit is effective.
<i>Limit applies to soft switching</i>	no <i>yes</i>	No limit for soft switching. Limit is effective.

6.6.5 Soft switching

Designation	Values	Description
Time for Soft ON	0 s, 1 s, 2 s, 4 s 6 s, 8 s, 12 s, 15 s 24 s, 30 s, 45 s, 1 min 2 min, 3 min, 4 min, 5 min 6 min, 7 min, 8 min, 9 min 10 min, 12 min, 15 min, 20 min 30 min, 40 min, 50 min, 60 min	Duration of dim up phase (t1) for soft switching (see appendix). 0 s = switch on immediately.  See appendix for further details: <u>Retriggering and premature switch off.</u>
Dimming value after Soft ON	10%, 20%, 30% 40%, 50%, 60%, 70%, 80%, 90%, 100%	Final value at the end of Soft ON phase (Val) Comment: Here again the configured <i>minimum dimming value</i> will be taken into account.
Response colour value with Soft ON	Keep last object value Use ETS parameter colour value at Soft ON	Note: at "Keep last object value" - if the object value is invalid, the preset colour of the ETS will be used.
Colour value at Soft ON (only visible if behaviour Colour value at Soft ON is set to Use ETS parameter)	Colour temperature 1000 K..10000 K [3000 K] RGB(W) / HSV(W) #000000 ... #FFFFFF White level #00 ... #FF	This parameter can be used to set which colour temperature is to be used for Soft ON. Setting in increments of 10. This parameter can be used to set which colour value is to be used for Soft ON.
Time between Soft ON and Soft OFF	until Soft OFF telegram 1 s, 2 s, 3 s, 4 s 5 s, 6 s, 7 s, 8 s, 9 s 10 s, 15 s, 20 s, 30 s 40 s, 50 s, 1 min, 2 min 3 min, 4 min, 5 min , 6 min 7 min, 8 min, 9 min, 10 min 12 min, 15 min, 20 min, 30 min, 40 min, 50 min, 60 min	No time restriction; Soft OFF phase is initiated by a telegram. Delay (t2) until the start of the Soft OFF phase.
Time for Soft OFF	0 s, 1 s, 2 s, 4 s 6 s, 8 s, 12 s, 15 s 24 s, 30 s, 45 s, 1 min 2 min, 3 min, 4 min, 5 min 6 min, 7 min, 8 min, 9 min 10 min, 12 min, 15 min, 20 min, 30 min, 40 min, 50 min, 60 min	Duration of the Soft OFF phase (t3). 0 s = switch off immediately  See appendix for further details: <u>Retriggering and premature switch off.</u>
Dimming value after Soft OFF	0% , 10%, 20%, 30% 40%, 50%, 60%, 70%, 80%, 90%, 100%	Final value at the end of the Soft OFF phase (Val) Comment: Here again the configured <i>minimum and maximum dimming value</i> will be taken into account.

Designation	Values	Description
Response colour value with Soft OFF	Keep last object value Use ETS parameter colour value at Soft OFF	Note: at "Keep last object value" - if the object value is invalid, the preset colour of the ETS will be used.
Colour value at Soft OFF (only visible if behaviour Colour value at Soft OFF is set to Use ETS parameter)	Colour temperature 1000 K..10000 K [3000 K] RGB(W) / HSV(W) #000000 ... #FFFFFF White level #00 ... #FF	This parameter can be used to set which colour temperature is to be used for Soft OFF. Setting in increments of 10. This parameter can be used to set which colour value is to be used for Soft OFF.

6.6.6 Block function

Designation	Values	Description
Block telegram	Block with 1 (standard) Block with 0	0 = cancel block 1 = block 0 = block 1 = cancel block  The block is always deactivated after reset.
Response when setting the block	no change 100% 0%, 10% , 20%, 30% 40%, 50%, 60%, 70%, 80%, 90%	No response. Dim to the set value.
Response when the block is cancelled	no change Update 100%, 0%, 10%, 20%, 30%, 40%, 50%, 60%, 70%, 80%, 90%	No response. If a telegram were received during the block: Apply state. Otherwise: restore state before the block. Dim to the set value.

6.6.7 Feedback

Designation	Values	Description
<i>Format of 1-bit feedback</i>	<i>not inverted</i> <i>inverted</i>	Standard setting: 1-100% = 1 0% = 0 1-100% = 0 0% = 1
<i>Send 1-bit feedback cyclically</i>	<i>no</i> <i>yes</i>	Send at regular intervals?
<i>Send 8-bit feedback</i>	<i>only after ending the dimming process</i> <i>every 10%</i> <i>every 20%</i> <i>every 30%</i>	Only send current dimming value when the new dimming value has been reached. Send even during the dimming process.
<i>Send 8-bit feedback cyclically</i>	<i>no</i> <i>yes</i>	Send at regular intervals?
<i>Time for cyclical transmission of feedback (if available)</i>	<i>2 min, 3 min, 5 min, 10 min, 15 min, 20 min, 30 min, 45 min, 60 min</i>	At what interval? This setting applies for both feedback objects (1 and 8-bit).

6.6.8 Force

Designation	Values	Description
<i>Format of force object</i>	1 bit 2 bit 1 byte (%)	Force is triggered by: Switch telegram. Priority telegram. Dimming value.
1 bit		
<i>Activate force function with</i>	1 0	Recommended. The polarity of the object is inverted. ¹
<i>Behaviour at start of force</i>	no change <i>minimum dimming value</i> 100% OFF 10%, 20%, 30% 40%, 50%, 60% 70%, 80%, 90%	Response to the receipt of a force telegram. Here again the configured <i>minimum dimming value</i> will be taken into account.
<i>Behaviour at end of force</i>	<i>update</i> ² Value before force <i>minimum dimming value</i> 100% OFF 10%, 20%, 30% 40%, 50%, 60% 70%, 80%, 90%	Response to cancellation of force. Here again the configured <i>minimum dimming value</i> will be taken into account.
2 bit		
<i>Behaviour at force ON</i>	<i>no change</i> <i>minimum dimming value</i> 100% OFF 10%, 20%, 30% 40%, 50%, 60% 70%, 80%, 90%	Response to the receipt of a force telegram. Here again the configured <i>minimum dimming value</i> will be taken into account.
<i>Behaviour at force OFF</i>	OFF	-
<i>Behaviour at end of force</i>	<i>update</i> ³ Value before force	Response to cancellation of force. Here again the configured <i>minimum dimming value</i> will be taken into account.

¹ After reset/download, forced operation is **not** activated.

² 4-bit commands received during the force (brighter/darker) will not be considered. Soft ON and Soft OFF processes will be aborted.

³ 4-bit commands received during the force (brighter/darker) will not be considered. Soft ON and Soft OFF processes will be aborted.

Designation	Values	Description
	<i>minimum dimming value</i> 100% OFF 10%, 20%, 30% 40%, 50%, 60% 70%, 80%, 90%	
1 byte (%)		
<i>Behaviour at end of force</i>	<i>update⁴</i> <i>Value before force</i> <i>minimum dimming value</i> 100% OFF 10%, 20%, 30% 40%, 50%, 60% 70%, 80%, 90%	Response to cancellation of force. Here again the configured <i>minimum dimming value</i> will be taken into account.

6.6.9 Scenes

One dimming channel can participate in up to 8 scenes.

Designation	Values	Description
<i>Block telegram for scenes</i>	<i>Block with 1 (standard)</i> <i>Block with 0</i>	0 = cancel block 1 = block 0 = block 1 = cancel block Note: With this setting, the scenes are always blocked immediately after reset or download.
<i>All channel scene statuses</i>	<i>Overwrite on download</i>	A download deletes all scene memories in a channel, i.e. all previously taught-in scenes. When a scene number is called, the channel assumes the configured assigned dimming value (see below). See appendix: <u>Entering scenes without telegrams</u>

⁴ 4-bit commands received during the force (brighter/darker) will not be considered. Soft ON and Soft OFF processes will be aborted.

Designation	Values	Description
	<i>Unchanged after download</i>	All previously taught-in scenes are saved. However, the scene numbers to which the channel should react can be changed (see below: Channel reacts to).
<i>Participation in central scene object</i>	no yes	Should the device react to the central scene object?
<i>Channel reacts to</i>	<i>No scene number</i> Scene number 1 ... <i>Scene number 63</i>	First of the 8 possible scene numbers to which the channel is to react.
<i>Assigned dimming value</i>	<i>Off</i> 10%, 20%, 30% 40%, 50%, 60%, 70%, 80%, 90%, 100%	New dimming value to be assigned to the selected scene number. Only possible if the scene statuses are to be overwritten after download.
<i>Behaviour when receiving the scene number</i>	<i>0 = immediate on</i> 1 = soft on at dimming speed 1 <i>2 = soft on at dimming speed 2</i> <i>3 = soft on at dimming speed 3</i>	The behaviour is identical to receiving an absolute dimming value.
<i>Permit teach-in</i>	<i>no</i> Yes	Scenes can only be called up. The user can both call up and teach in or amend scenes.
<i>Colour value</i>	RGB RGBW Colour temperature	When colour control is activated, a colour value can be assigned to the selected scene number. The parameter Type of colour control defines which values are available.

6.6.10 Hour counter and service

Designation	Values	Description
<i>Type of hour counter</i>	Hour counter	Forward counter for channel duty cycle.
	<i>Counter for time to next service</i>	Backward counter for channel duty cycle.
Hour counter		
<i>Reporting of operating hours in the event of a change (0..100 h, 0 = no report)</i>	0..100 Default value = 10	At what interval is the current counter reading to be sent? Example: 10 = Send each time the counter reading increases by another 10 hours.
<i>Report operating hours cyclically</i>	No yes	Send at regular intervals?
<i>Time for cyclical transmission</i>	2 minutes, 3 minutes, 5 minutes, 10 minutes, 15 minutes, 20 minutes, 30 minutes, 45 minutes 60 minutes	At what interval?
Counter for time to next service		
<i>Service interval (x10 h)</i>	0..2000 Default value = 100	Desired timescale between 2 services. Example: 10 = 10 x 10 h = 100 hours
<i>Reporting of time to service in the event of a change (0 = no report)</i>	0..100 Default value = 10	At what interval is the current counter reading to be sent? Example: 10 = Send each time the counter reading decreases by another 10 hours.
<i>Report time to service cyclically</i>	no Yes	Send remaining time to next service at regular intervals? → Object Time to next service.
<i>Report service cyclically</i>	no Yes	Send expiry of time to next service at regular intervals? → Object Service required.
<i>Time for cyclical transmission (if used)</i>	2 minutes, 3 minutes, 5 minutes, 10 minutes, 15 minutes, 20 minutes, 30 minutes, 45 minutes 60 minutes	At what interval?

6.6.11 Diagnostic messages

Designation	Values	Description
<i>Send general error cyclically</i>	no Yes	Which messages should be sent cyclically?
<i>Send lamp failure cyclically</i>	no Yes	
<i>Send DALI fault cyclically</i>	no Yes	
<i>Send mains failure cyclically</i>	no Yes	
<i>Cycle time for all diagnostic messages (if used)</i>	2 minutes, 3 minutes, 5 minutes, 10 minutes, 15 minutes, 20 minutes, 30 minutes, 45 minutes 60 minutes	At what interval?

6.6.12 Power failure and restoration

Designation	Values	Description
<i>Dimming value during download and bus failure</i> (During bus failure, the DALI computer can still be supplied via the mains. The behaviour during download or bus failure can be set via this parameter)	same as before failure 100%, 0%, 10%, 20%, 30% 40%, 50%, 60% 70%, 80%, 90%	Restore status before download or maintain status before bus failure. Apply set value here. Here again the configured minimum dimming value will be taken into account.
<i>Dimming value during restoration of the mains or bus supply</i>	same as before failure 100%, 0%, 10%, 20%, 30% 40%, 50%, 60% 70%, 80%, 90%	Restore status before failure. Apply set value here. Here again the configured minimum dimming value will be taken into account.

The colour value for permanent is used as the colour

7 Application example

7.1 Bedroom lighting

The light should not be blinding when switching on at night, otherwise it should light up immediately at 100%.

All dimming values should, however, be configurable via the dimming function:

- At night, the switch-on value should not exceed the 40% limit
- Dimming up to 100% should still be possible (e.g. when reading)
- No restrictions during the day
- Dimming via 2 buttons

7.1.1 Devices:

- DM 4 DALI KNX (4940300)
- TA 2 S (4969222)
- TR 648 top2 (6489210)
- 2 conventional buttons (NO contact)

7.1.2 Overview

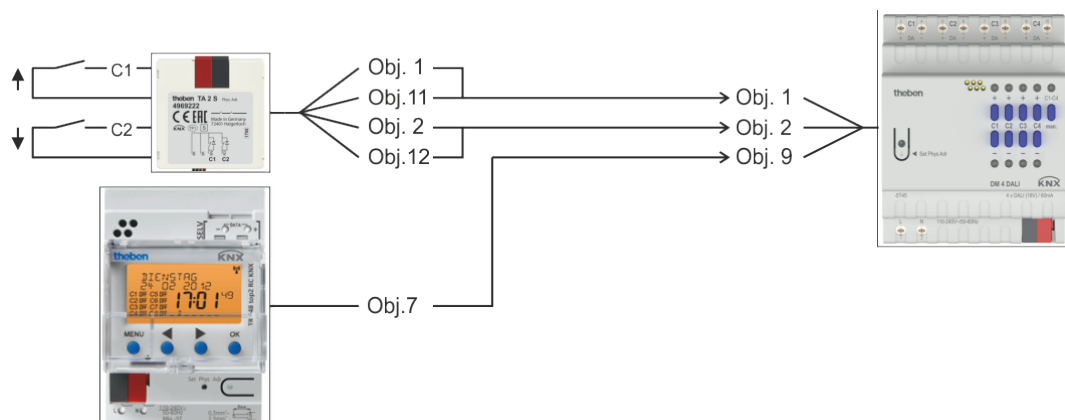

7.1.3 Objects and links

No.	TA 2 S	No.	DM 4 DALI KNX	Comment
	Object name		Object name	
1	Channel I1 switching*	1	Switching On/Off	Switch on light via button 1 (brief button press)
2	Channel I1 brighter**	2	brighter / darker	Button 1 (brighter)
11	Channel I2 switching*	1	Switching On/Off	Switch off light via button 2 (brief button press)
12	Channel I2 brighter**	2	brighter / darker	Button 2 (darker)

* A common group address for both objects

** A common group address for both objects

No.	TR 648 top2	No.	DM 4 DALI KNX	Comment
	Object name		Object name	
7	C1.1 switching channel per cent	9	Dimming value limit	1-100% = limit 0 = No limit.

7.1.4 Important parameter settings

Standard or customer-defined parameter settings apply to unlisted parameters.

DM 4 DALI KNX

Parameter page	Parameters	Setting
Channel C1: Configuration options	Adjust dimming value limits	yes
Dimming response	Switch-on value	100%
Dimming value limits	Perform limit in describing object	yes
	Limit applies to switch command	yes
	Limit applies to relative dimming	no
	Limit applies to absolute dimming	no
	Limit applies to soft switching	yes

TA 2 S

Parameter page	Parameters	Setting
Channel 1	Channel function	Dimming
	Response to long / short	brighter / On
Channel 2	Channel function	Dimming
	Response to long / short	darker / Off

TR 648 top2

Parameter page	Parameters	Setting
General	Activate time switch channel C1	yes
Switching channel C1	Telegram type C1.1	Percentage value
	With clock → ON	send following telegram once
	Telegram (%)	40
	With clock → OFF	send following telegram once
	Telegram (%)	0

8 Appendix

8.1 Priority order

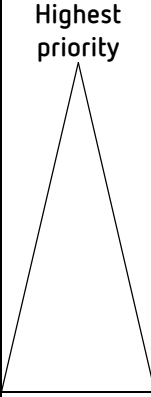
	1	Buttons	The channel buttons have the highest priority and can overwrite Permanent On.
	2	Permanent On	The dimming values for Permanent Off are ignored during Permanent On.
	3	Permanent Off	The dimming values for Force are ignored during Permanent Off.
	4	Force	The dimming values for Block and Scene are ignored during Force.
	5	Block, scene	During a block, the objects for switching are ignored. However, they will be processed if they are needed when the block is removed. Block and scene are equal.
Lowest priority	6	Switching	A new object overwrites the switching status of previous objects. All objects are equal.

8.2 Use of the soft switch function

8.2.1 General

The soft switching function is a cycle consisting of switch-on, dimming up, maintaining target brightness, dimming down and switch-off.

8.2.2 Soft switching for staircase lighting

The following function is recommended for staircase lighting:

When the light button is pressed: Full brightness.

After the desired time has elapsed: Slow dimming down and basic lighting.

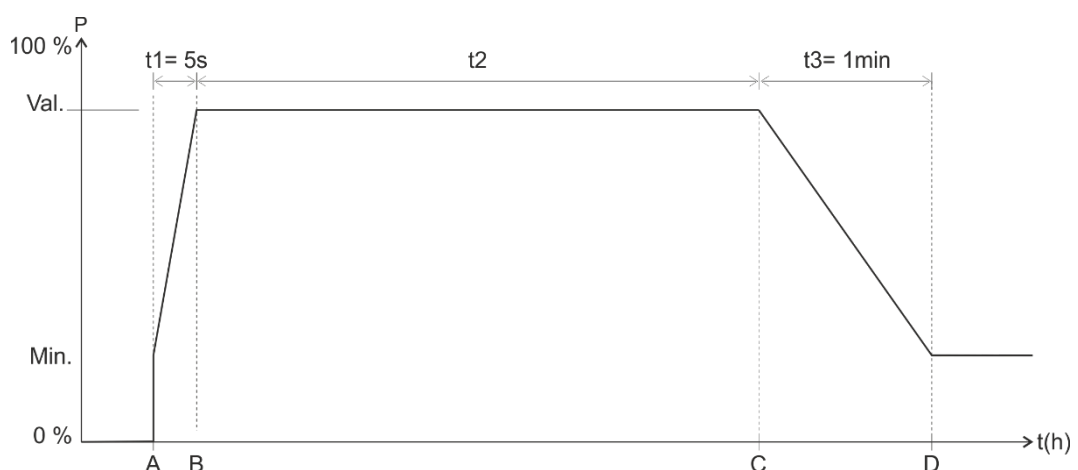

A	Button sends <i>Soft ON</i> telegram.
---	---------------------------------------

t1	The <i>Soft ON</i> time is equal to 0, i.e. the "Dim up slowly" function is deactivated
B	The brightness is immediately adjusted to the configured value after <i>Soft ON</i>
t2	Configured time between <i>Soft ON</i> and <i>Soft OFF</i> ⁵ elapses
t2+	It is possible for t2 to be extended with another <i>Soft ON</i> telegram
C	t2 or t2+ has elapsed, or a <i>Soft OFF</i> telegram was received: Start of the <i>Soft OFF</i> phase
t3	the brightness is gradually reduced within the configured time for <i>Soft OFF</i>
D	t3 has elapsed and it is dimmed to the configured value after <i>Soft OFF</i> (e.g. 25%). The configured minimum and maximum dimming value is taken into account

The light can be switched off with a *Soft OFF* telegram or dimmed to the value after *Soft OFF*. A *Soft ON* telegram can be used to retrigger.

⁵ *Soft OFF* via configured time or via *Soft OFF* telegram.

8.2.3 Driveway lighting

A motion detector activates the dimmer via the *soft switching* object.
 The lighting is dimmed up within 5 seconds if a movement is detected.
 This delay gives the eyes enough time to adjust to the light without being dazzled.
 The lighting is gradually dimmed down within a minute and then switched off after the configured time has elapsed or a Soft OFF telegram is received via the button or via the motion detector (cyclic).

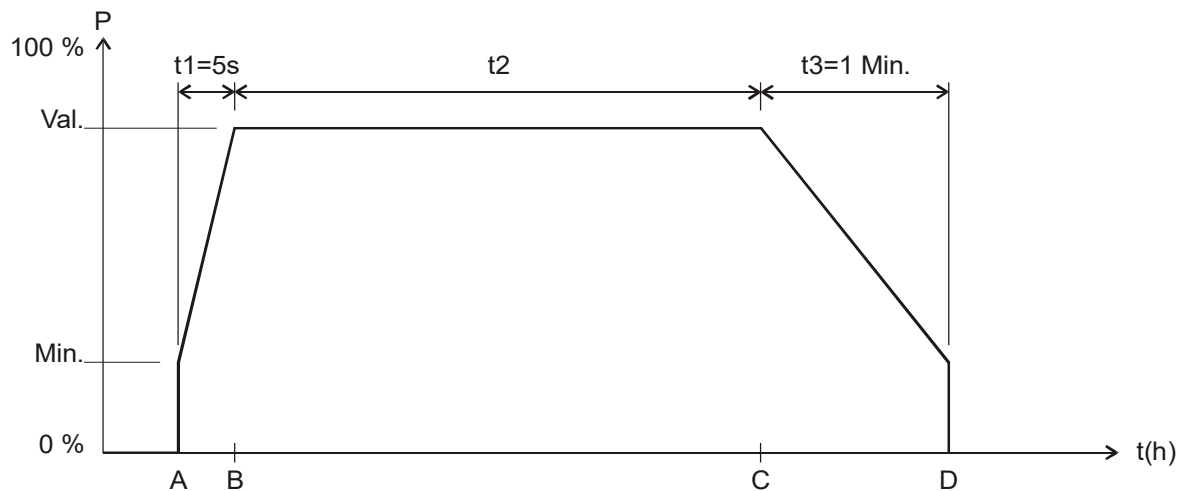

A	<i>Soft ON</i> is sent by the motion detector: The brightness is adjusted to the configured <i>minimum dimming value</i>
t1	The brightness is gradually increased within the configured time for <i>Soft ON</i> (5 s)
B	Configured value after <i>Soft ON</i> is reached
t2	Time between <i>Soft ON (1)</i> and <i>Soft OFF</i>
C	<i>Soft OFF</i> telegram was received or configured time has elapsed: Beginning of the <i>Soft OFF</i> phase
t3	The brightness is gradually reduced within the configured time for <i>Soft OFF</i>
D	t3 has elapsed and it is dimmed to the configured value after <i>Soft OFF</i> (0%). The configured minimum and maximum dimming value are taken into account

8.2.4 Simulation of daily routine

Using a time switch, it is possible to simulate an entire daily routine with sunrise and sunset. To do this, the *Time between Soft ON and Soft OFF* parameter will be set to *Until Soft OFF telegram* (See object *Soft switching*).

The time switch sends a Soft ON telegram (=1) in the morning and a Soft OFF telegram (=0) in the evening to object *Soft switching*.

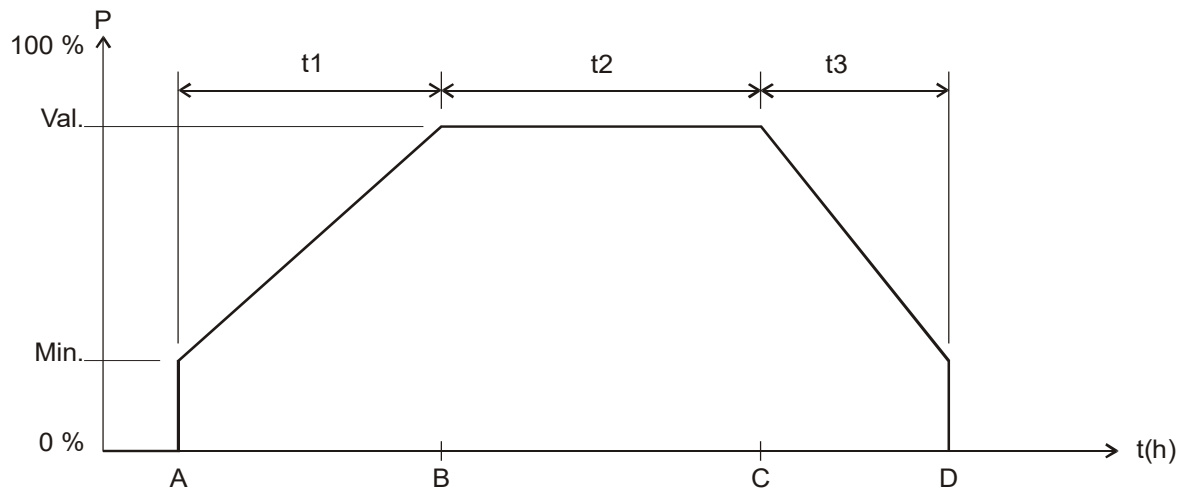

Min.	Configurable <i>Minimum dimming value</i>
Val.	Target dimming value, i.e. configured <i>Dimming value after Soft ON</i>
t(h)	Time sequence

A	<i>Soft ON</i> is sent by the clock: The brightness is adjusted to the configured <i>minimum dimming value</i>
t1	The brightness is gradually increased within the configured time for <i>Soft ON</i>
B	Configured <i>value after Soft ON</i> is reached
t2	Time programmed in the time switch between <i>Soft ON (1)</i> and <i>Soft OFF telegram (0)</i>
C	<i>Soft OFF</i> telegram has been received: Start of the <i>Soft OFF</i> phase
t3	The brightness is gradually reduced within the configured <i>time for Soft OFF</i>
D	t3 has elapsed and it is dimmed to the configured value after <i>Soft OFF (0%)</i> . The configured minimum and maximum dimming value are taken into account

8.2.5 Retriggering and premature switch off

It is also possible to influence the soft switching process while it is still active. Depending on which phase is currently being executed, the following responses can be triggered by Soft ON and Soft OFF telegrams.

Telegram	Response
Soft ON during t1	none
Soft ON during t2	t2 is restarted
Soft ON during t3	a new Soft ON process is started. See below.
Soft OFF during t1	The Soft ON process is stopped and the Soft OFF phase started immediately. See below.
Soft OFF during t2	the Soft OFF phase starts immediately
Soft OFF during t3	none

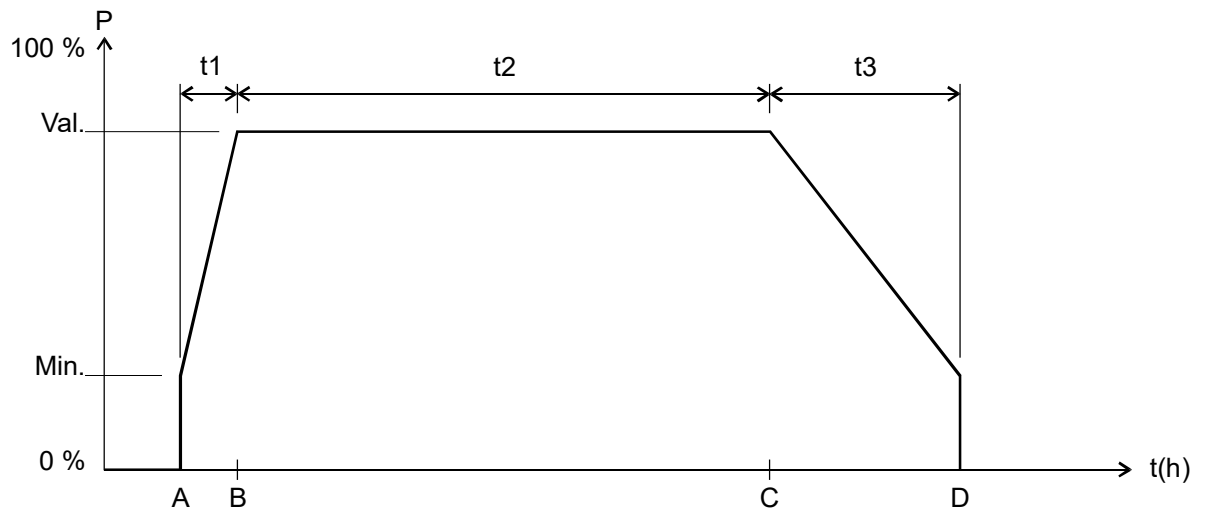

8.2.6 Soft OFF telegram during a Soft ON process

The duration of the Soft OFF phase ($t3'$) is always equivalent to the configured time regardless of the current dimming value.

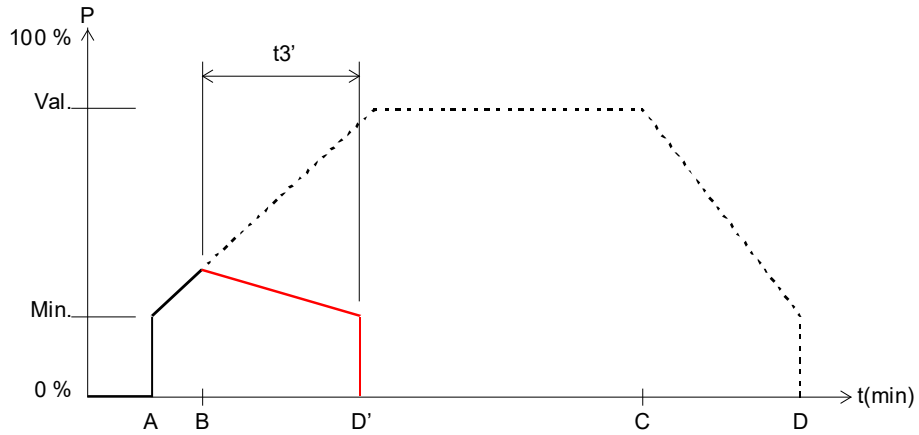

Example 1: Soft OFF at the start of the Soft ON phase.

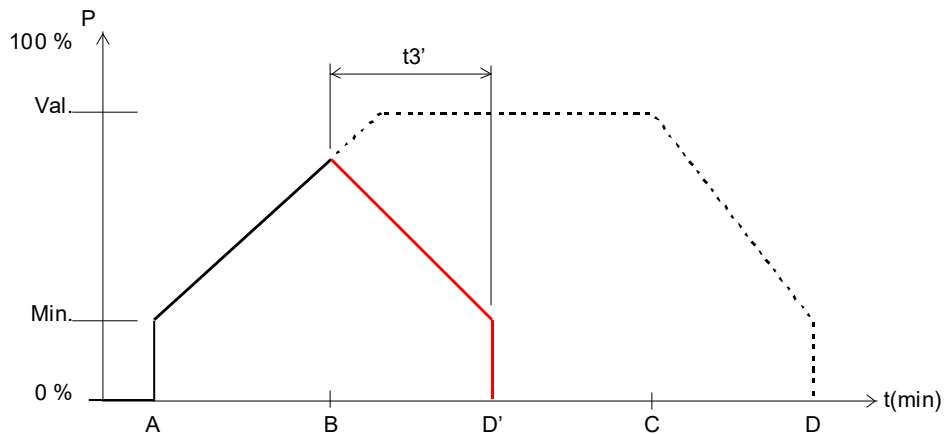

Example 2: Soft OFF at the end of the Soft ON phase.

A	A Soft ON process is started
B	A Soft OFF telegram is received: The Soft ON phase is interrupted and a Soft OFF phase starts.
$t3'$	Duration of the Soft OFF phase = configured Soft OFF time
D'	End of the Soft OFF phase

8.2.7 Soft ON telegram during a Soft OFF process

The duration of the Soft ON phase ($t1'$) is always equivalent to the configured time regardless of the current dimming value.

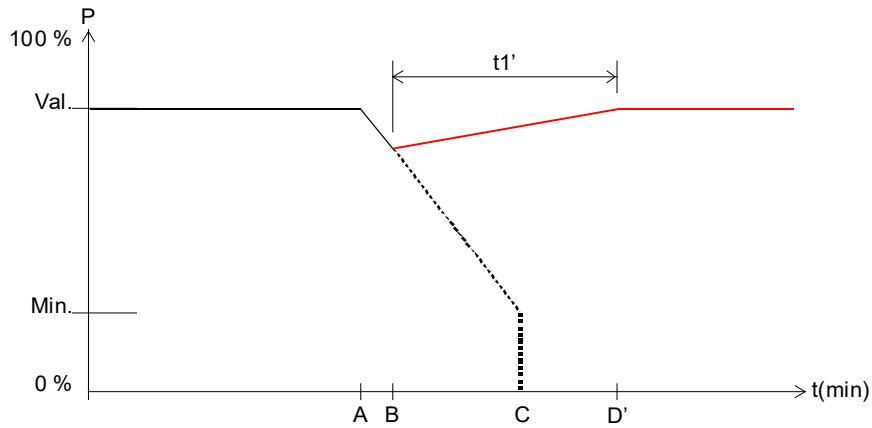

Example 3: Soft ON at the start of the Soft OFF phase.

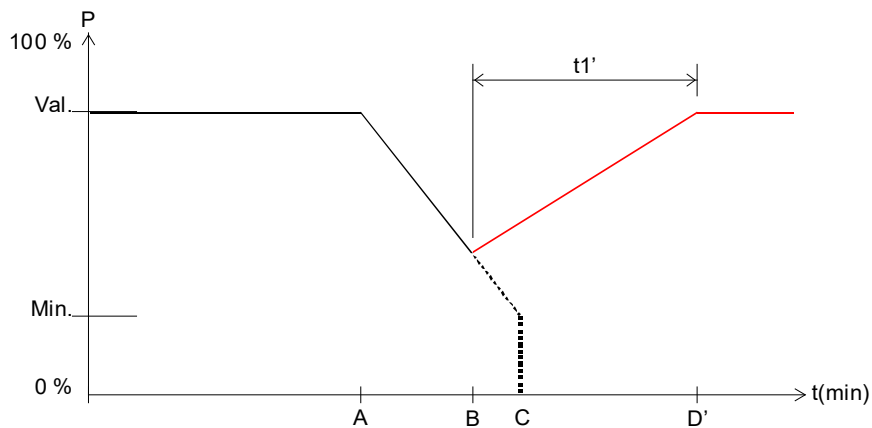

Example 4: Soft ON at the end of the Soft OFF phase.

Sequence:

A	A Soft OFF process is started
B	A Soft OFF telegram is received: The Soft OFF phase is interrupted and a Soft ON phase starts.
$t1'$	Duration of the Soft ON phase = configured Soft ON time
D'	End of the Soft ON phase

8.3 Use of the force function

Example: Lighting with brightness control during the daytime and minimum lighting during the night.

A brightness controller continuously measures the brightness of the room and controls the dimmer, to keep the brightness constant.

A dimming value of 20% is configured for forced operation.

In the evening at the close of work, the time switch activates forced operation, which dims down the brightness to 20%.

During the night, the lighting is switched on for a certain period of time by the night-watchmen via the central permanent ON function.

In the morning at the start of work, the time switch cancels the forced operation again and the dimmer is controlled by the brightness control.

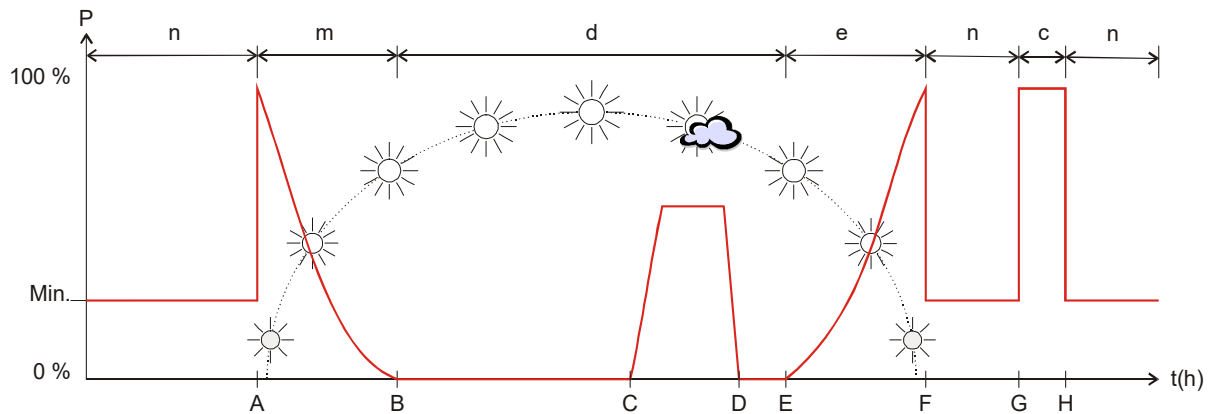

A	Forced operation is cancelled by the time switch. As the daylight is not yet bright enough, the brightness control controls the dimmer
B	The daylight is now bright enough to illuminate the room, and the dimmer is switched off
C	Heavy cloud cover, the dimmer compensates for the lack of bright daylight
D	Clear sunshine, the dimmer is turned back down
E	Late afternoon, the dimmer gradually replaces the receding daylight
F	Forced operation is activated by the time switch The dimmer reduces the light to 20%
G	Central permanent On = 1
H	Central permanent On = 0
n	During the night time, the configured value for forced operation applies
c	Night round of security guards: The lighting is switched on via central permanent On
m	Morning: Daylight increases and the brightness control slowly reduces the dimming value
e	Evening: Daylight decreases and the brightness control slowly increases the dimming value
d	During the daytime, the dimmer is controlled by the lighting control according to the brightness of the sunlight

8.4 DALI EB

8.4.1 General

Only DALI EBs with lamps approved for this purpose may be connected to the dimmer.

In the dimming response, both manufacturer- and type-related differences are noticeable, therefore it is recommended to operate only EBs and lamps of the same type in parallel on one channel.

It may be necessary to adjust the minimum dimming value for each parameter.

8.5 4-bit telegrams (brighter/darker)

8.5.1 Telegram format 4-bit EIS 2 relative dimming:

Bit 3	Bits 0-1-2	
Direction	Dimming range divided into increments	
	Code	Increments
Dim up: 1	000	Stop
Dim down: 0	001	1
	010	2
	011	4
	100	8
	101	16
	110	32
	111	64 ⁶

Examples: 1111 = dim brighter by 64 increments
 0111 = dim darker by 64 increments
 1101 = dim brighter by 16 increments

⁶ typical application.

8.5.2 The parameters: *Switching on/off with a 4-bit telegram*

In general, the setting *yes* is required.

The setting *no* is available for use with special customer requests, e.g. in conference rooms.

The situation is described as follows:

A whole group of dimmer channels is operated from a button (4-bit).

A certain lighting situation has been set by a scene or other means – e.g. channel 1 OFF, channel 2 40%, channel 3 50%. The requirement is to now dim up and increase the brightness of the entire scene, but the channels which are switched OFF should remain off.

The parameters *Switching on/off with a 4-bit telegram* block the usual switch on/off function of the 4-bit telegram.

Parameter <i>Switch-on with 4-bit telegram</i>	4-bit Telegram	Dimmer output status	Response
<i>yes</i>	brighter / darker	Switched on (1%...100%)	Channel is normally dimmed.
	brighter	Off	Channel is switched on and dimmed brighter.
<i>no</i>	brighter	Off	Dimmer remains switched off.
	brighter / darker	Switched on (1%...100%)	Channel is normally dimmed.

Parameter <i>Switching off with a 4-bit telegram</i>	4-bit Telegram	Dimmer output status	Response
<i>yes</i>	brighter / darker	Switched on (1%...100%)	Channel is normally dimmed.
	darker	On	The channel is switched off if the button is kept depressed for longer than approx. 2 s when the minimum brightness is reached.
<i>no</i>	darker	On	Channel can be dimmed down to the minimum brightness, but is not switched off.
	brighter / darker	Switched on (1%...100%)	Channel is dimmed in range from min. to 100% and remains switched on.

8.6 The scenes

8.6.1 Principle

The current status of a channel, or of a complete device, can be stored and retrieved later at any time via the scene function.

Each channel can participate simultaneously in up to 8 scenes.
Scene numbers 1 to 64 are permitted.

Permission to participate in scenes must be granted for the relevant channel via parameter.
See *Activate scenes* parameter and **Scenes** parameter page.

The current status is allocated to the appropriate scene number when a scene is saved.
The previously saved status is restored when a scene number is called up.

This allows a device to be easily integrated into any chosen user scene.

The scenes are permanently stored and remain intact even after the application has been downloaded again.
See "All channel scene statuses" parameter on the **Scenes** parameter page.

8.6.2 Calling up or saving scenes:

To call up or save a scene, the relevant code is sent to the corresponding scene object.

Scenario	Call up		Save	
	Hex.	Dec.	Hex.	Dec.
1	\$00	0	\$80	128
2	\$01	1	\$81	129
3	\$02	2	\$82	130
4	\$03	3	\$83	131
5	\$04	4	\$84	132
6	\$05	5	\$85	133
7	\$06	6	\$86	134
8	\$07	7	\$87	135
9	\$08	8	\$88	136
10	\$09	9	\$89	137
11	\$0A	10	\$8A	138
12	\$0B	11	\$8B	139
13	\$0C	12	\$8C	140
14	\$0D	13	\$8D	141
15	\$0E	14	\$8E	142
16	\$0F	15	\$8F	143
17	\$10	16	\$90	144
18	\$11	17	\$91	145
19	\$12	18	\$92	146
20	\$13	19	\$93	147
21	\$14	20	\$94	148
22	\$15	21	\$95	149
23	\$16	22	\$96	150
24	\$17	23	\$97	151
25	\$18	24	\$98	152
26	\$19	25	\$99	153
27	\$1A	26	\$9A	154
28	\$1B	27	\$9B	155
29	\$1C	28	\$9C	156
30	\$1D	29	\$9D	157
31	\$1E	30	\$9E	158
32	\$1F	31	\$9F	159
33	\$20	32	\$A0	160
34	\$21	33	\$A1	161
35	\$22	34	\$A2	162
36	\$23	35	\$A3	163
37	\$24	36	\$A4	164
38	\$25	37	\$A5	165
39	\$26	38	\$A6	166
40	\$27	39	\$A7	167
41	\$28	40	\$A8	168
42	\$29	41	\$A9	169
43	\$2A	42	\$AA	170
44	\$2B	43	\$AB	171
45	\$2C	44	\$AC	172
46	\$2D	45	\$AD	173
47	\$2E	46	\$AE	174
48	\$2F	47	\$AF	175
49	\$30	48	\$B0	176
50	\$31	49	\$B1	177

Scenario	Call up		Save	
	Hex.	Dec.	Hex.	Dec.
51	\$32	50	\$B2	178
52	\$33	51	\$B3	179
53	\$34	52	\$B4	180
54	\$35	53	\$B5	181
55	\$36	54	\$B6	182
56	\$37	55	\$B7	183
57	\$38	56	\$B8	184
58	\$39	57	\$B9	185
59	\$3A	58	\$BA	186
60	\$3B	59	\$BB	187
61	\$3C	60	\$BC	188
62	\$3D	61	\$BD	189
63	\$3E	62	\$BE	190
64	\$3F	63	\$BF	191

Examples (central or channel-related):

Call up status of scene 5:

→ Send \$04 to the relevant scene object.

Save current status with scene 5:

→ Send \$84 to the relevant scene object.

8.6.3 Teaching in scenes without telegrams

Instead of defining scenes individually by telegram, this can be done in advance in the ETS. This merely requires the *All channel scene statuses* parameter (**Scenes** parameter page) to be set to *Overwrite on download*.

The required status can then be selected for each of the 8 possible scene numbers in a channel (= *Status after download* parameter). After the download, the scenes are already programmed into the device.

Later changes via teach-in telegrams are possible if required and can be permitted or blocked via a parameter.

8.6.4 Storing light scenes in a button

Scenes are normally stored in the dimmer itself. The object *Call up/save scenes* is used for this purpose.

However, if the light scenes are to be stored **externally**, for example with a scene-capable button, the following steps can be taken: The dimmer has one dimming object (*dimming value*) and one feedback object (*feedback in %*). 2 group addresses are used here; hereafter referred to as "Gr.addr.1" and "Gr.addr.2".

8.6.5 Allocation of group addresses and setting of object flags

	Object	Connect with	set to sending	Flags			
				C	R	W	T
BUTTON	Brightness value telegram	Gr.Addr.1	yes	✓	-	✓	✓
		Gr.Addr.2	no				
DIMMER	Dimming value	Gr.Addr.1	x	✓	-	✓	x
	Feedback in %	Gr.Addr.1	no	✓	✓	-	x
		Gr.Addr.2	yes				

x = user-defined

Feedback to the dimmer should **not** be configured for *cyclical sending*.

Flags:

C = Communication

R = Read

W = Write

T = Transmit

8.7 Conversion of percentages to hexadecimal and decimal values

Percentage value	0%	10%	20%	30%	40%	50%	60%	70%	80%	90%	100%
Hexadecimal	00	1A	33	4D	66	80	99	B3	CC	E6	FF
Decimal	00	26	51	77	102	128	153	179	204	230	255

All values from 00 to FF hex. (0 to 255 dec.) are valid.